

Eaton SB2128092YZ

Catalog Number: SB2128092YZ

Eaton B-Line series runway horizontal to vertical transition kit, 13" height, 13" length, 9" width, Steel, ASTM A570 structural steel, Includes transition section, cable support bar, Yellow zinc

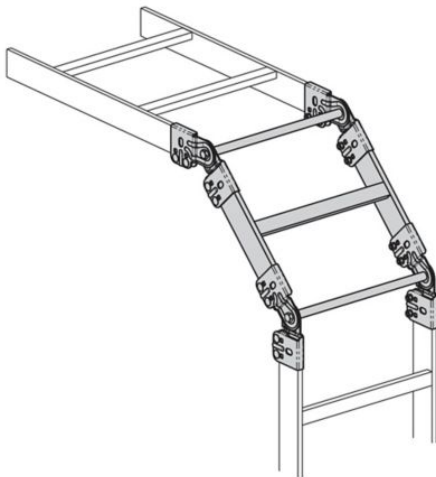

General specifications

Product Name	Catalog Number
Eaton B-Line series runway horizontal to vertical transition kit	SB2128092YZ
	UPC
	799038018285
Product Length/Depth	Product Height
13 in	13 in
Product Width	Product Weight
9 in	12.9 lb
Certifications	
UL Classified	

Product specifications

Special features

Includes transition section, cable support bar

Type

Adjustable runway horizontal to vertical transition kit

Material

Steel

Material details

ASTM A570 structural steel

Application

Used for an equipment grounding conductor

Resources

Brochures

[Redi-Rail runway brochure](#)

Catalogs

[Cable runway and accessories section of datacomm catalog](#)

Specifications and datasheets

[Eaton Specification Sheet - SB2128092YZ](#)



Eaton Corporation plc
Eaton House
30 Pembroke Road
Dublin 4, Ireland
Eaton.com
© 2023 Eaton. All Rights Reserved.

Eaton is a registered trademark.

All other trademarks are property of their respective owners.



[Eaton.com/socialmedia](https://www.eaton.com/socialmedia)